

DRAWING AND PARTS LIST FOR 2545

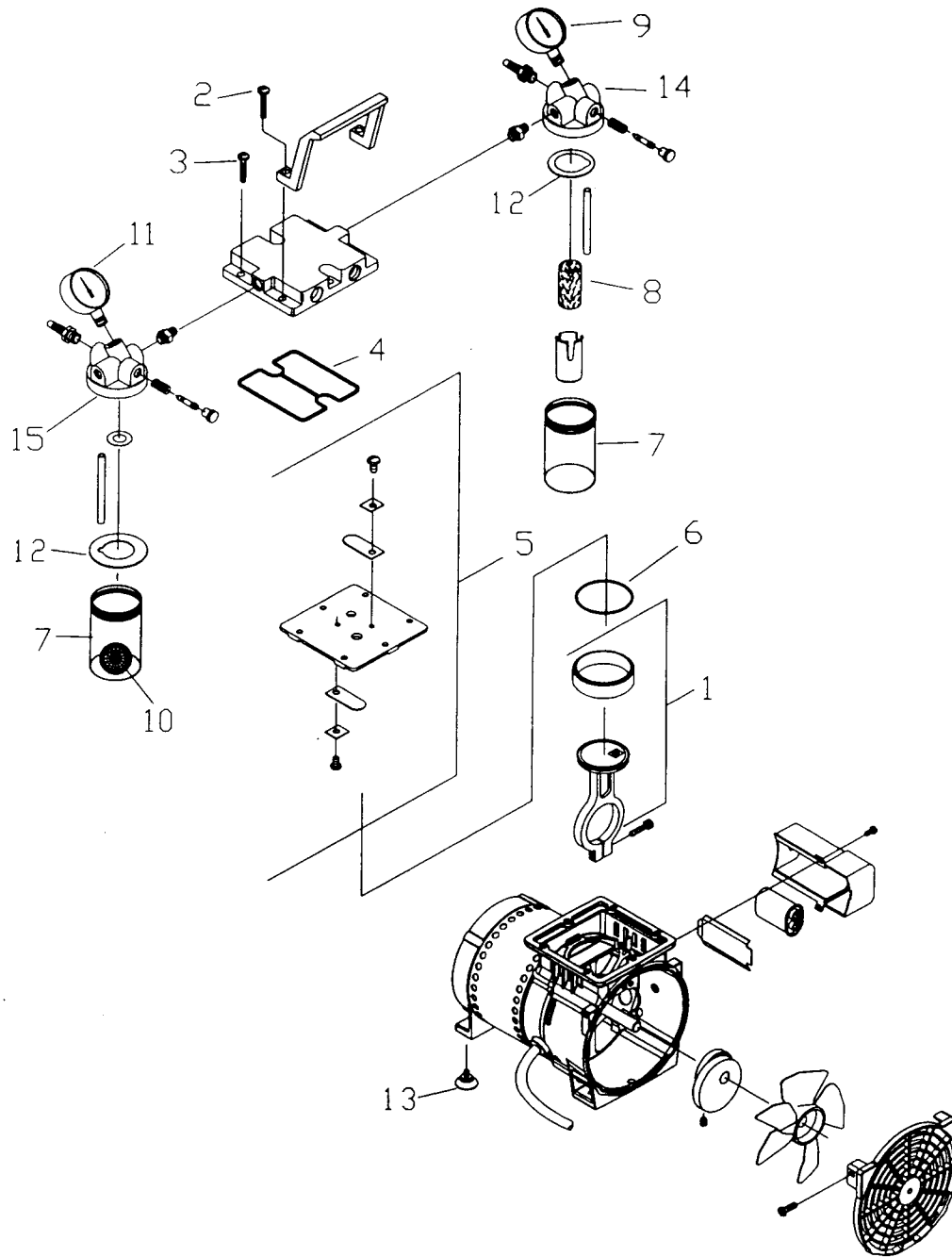

Parts List For Model 2090

Item No.	Qty	Part No.	Description	Diaphragm Service Kit 2090K-01	Valve Plate Service Kit 2090K-02
13	2	Note 1	Valve Keeper		1
14	4	Note 1	Screw-Valve Flapper-Intake		1
15	10	Note 1	Screw-Valve Plate		5
16	4	Note 1	Screw-Valve Flapper-Exh		5
17	2	Note 1	Valve Plate Gasket		1
18	4	Note 1	Valve Flapper – Intake & Exh		2
22	2	2090K-03	Connecting Rod		
23	2	Note 1	Diaphragm	1	
24	8	Note 1	Screw-Hold Down Plate	4	
25	2	Note 1	Hold Down Plate	1	
26	2	Note 1	Teflon Liner	1	
28	1	1412C	Silencer		

Note 1: These parts are not available, but are supplied within kits.